

ClassicBond Installation Guide

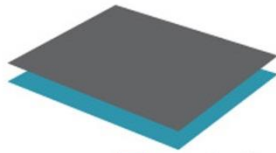

ClassicBond[®]

the original and still the best EPDM

Field Installation Guide

ClassicBond Installation Guide

CONTENTS

General Information & Precautions	3
Tools, Equipment & Roof Surface Preparation	4
Membrane Installation	
Installation of ClassicBond roofing	5 & 6
Base Tie-in Detail	7 & 8
Bonding Adhesive	9
Pipes/Penetrations in membrane	10
Skylights, Chimneys	11
Perimeter Wall & Vertical Terminations	12
76mm Seam Tape	13
150mm PS Cover Strip	14
Pressure Sensitive Details	
T-Joint Cover Patch	15
Internal Corner Details	16
External Corner Details	17
Prefabricated Pipe Boot	18
Pipe & Penetration Flashing	19
Roof Outlets/Drains	
Anti-Back-up 68mm Outlet	20
ClassicBond Top Drain Outlet	21
Angled Roof Drain Outlet	22
On-site Fabricated Outlet	23
EPDM to BUR Join	24
Perimeter Terminations	
Sure Edge PVC Gutter Trims	25 & 26
Sure Edge PVC Kerb Trims	27 & 28

ClassicBond Installation Guide

GENERAL INFORMATION

This Rooftop Guide has been designed to give the user a GENERAL overview of the application of a ClassicBond EPDM roof. This Guide is intended as broad reference aid and is not intended or meant to be all-inclusive.

PRECAUTIONS

If the bonding adhesive is not allowed to properly dry, gas bubbles or blisters may form under the membrane sheet. These bubbles or blisters may subside over time.

Due to solvent flash off, condensation may form on freshly applied adhesive when the ambient temperature is near the dew point. If condensation develops, possible surface contamination may occur and the application of adhesive must be discontinued. Allow the surface to dry and when conditions allow apply a thin refresher coat at a coverage rate that is approximately half of the normal coverage rate when re-adhering a previously coated surface.

Extreme care must be exercised when working on ladders, roofs, or at elevations above ground. If used as an emergency repair to a roofing system, contact the roofing system manufacturer for compatibility and to ensure compliance with terms and limitations of the warranty.

Surface can be slippery when wet, damp, or frost covered.

Do not stretch the product during installation.

Do not expose product to temperatures in excess of 82° C (180°F).

This product is not intended for use where roof top traffic or activity is anticipated without a protective layer installed on its surface.

THIS INFORMATION AS WELL AS INFORMATION CONTAINED IN THE MATERIAL SAFETY DATA SHEET AND ON PRODUCT PACKAGING MUST BE REVIEWED PRIOR TO STORAGE, HANDLING OR USE OF THESE PRODUCTS.

ClassicBond Installation Guide

TOOLS & EQUIPMENT

- 2" hand roller
- Hammer
- Hook blade knife/Scissors
- Pencils/Chalk Line
- 225mm medium nap roller on pole
- Chalk line
- Safety glasses
- Tape Measure
- 50-75mm brushes
- Stirrers for adhesive and primer
- Solvent resistant gloves
- Soft bristle broom
- Caulk gun
- Scrubbing pads for EPDM primer

ROOF SURFACE PREPARATION

The ClassicBond fully-adhered system will adhere to wood, wood fibreboard and lightweight concrete. This product may NOT be applied to polystyrene insulation. The ClassicBond Water Based Acrylic Adhesive is intended for bonding to timber surfaces only. Other surfaces must be bonded with ClassicBond Bonding Adhesive. Roofs over 100m² must also be installed with Bonding Adhesive.

Be sure the roof surface is clean, free of dust, dirt, rust, oil, grease, and loose material. The roof surface must be dry. This product will not adhere to wet or damp surfaces. Trapped moisture may vaporize and negatively affect the performance of this product.

Good roofing practice dictates that ponding water be prevented. The roof surface should have a positive slope of at least 1 in 80 to prevent ponding water conditions. Before starting please consult the "Precautions" section at the beginning of this manual.

ClassicBond Installation Guide

INSTALLATION OF CLASSICBOND ROOFING

- Unroll the ClassicBond EPDM membrane over the substrate so that the sheet is in the desired position and is wrinkle free.
- The ClassicBond Water Based Acrylic Adhesive is intended for bonding to timber surfaces only. Other surfaces must be bonded with ClassicBond Bonding Adhesive. Roofs over 100m² must also be installed with Bonding Adhesive.
- It is essential for ClassicBond EPDM membrane is allowed to relax prior to adhering. The time required for this will vary depending on weather conditions.
- Cut the membrane to length if required, and position the sheet to achieve an overhang off the roof of at least 75mm (3") for both the length and width.
- The RUSS (Reinforced Universal Secure Strip) should already be installed wherever the membrane turns up through an angle change.
- Fold the sheet onto itself so that one-half of the sheet is exposed; take care to avoid wrinkles.



ClassicBond Installation Guide

- Open and thoroughly stir the [ClassicBond WBA Adhesive](#) or Bonding Adhesive. Using a medium nap paint roller apply the adhesive to the substrate, or if using Bonding adhesive, the rear of the membrane as well.
- The adhesive must be applied to 100% of the surface in an even coat without globs or puddles. The adhesive can alternatively applied in a thin coat to the membrane and substrate.
- Roll the sheet onto the coated substrate avoiding wrinkles by rolling the middle of the sheet first. Immediately after rolling the sheet into the adhesive, broom the membrane sheet to achieve maximum contact.



- DO NOT apply excessive pressure to cause the membrane to wrinkle.
- Repeat the application of ClassicBond WBA adhesive for the other half of the ClassicBond EPDM membrane.

NOTE: DO NOT APPLY WBA or BONDING ADHESIVE TO ANY SEAM AREAS.

ClassicBond Installation Guide

BASE TIE-INS

In common with most single ply material EPDM will, overtime, try to shrink by up to 10% back to the centre. The base tie-in controls the membrane movement and stops the membrane pulling away where the membrane turns up through an angle change. The rest of the movement is accommodated by the ClassicBond membrane and its ability to elongate by over 300%.

ClassicBond PS RUSS (Reinforced Universal Secure Strip) is used to mechanically secure EPDM membranes to the substrate. The strip has tape pre-applied along one edge, and can be installed horizontally or vertically in conjunction with Seam Fastening Plates below the EPDM membrane for additional membrane securement.

Seam Fastening Plates are used with RUSS strip to securely clamp the RUSS to the vertical or horizontal surface; these must be used in conjunction with the appropriate fasteners for the substrate.

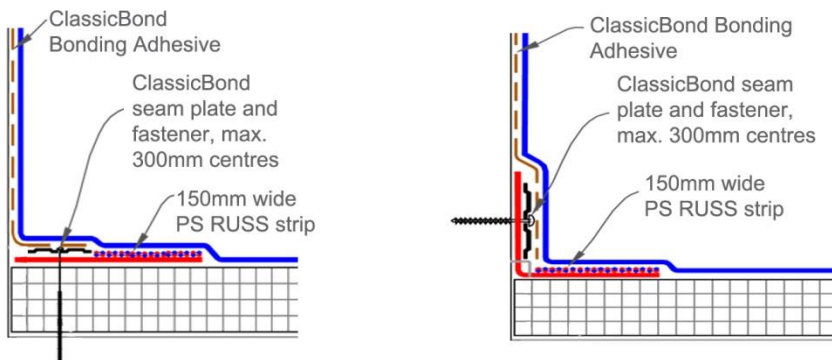

Other UK EPDM distributors state that base ties-ins aren't required on roofs under 100m². The membrane, irrelevant of size, will pull to the centre and eventually pull away from the wall.

Remember, the membrane doesn't know whether it's under or over 100m².

ClassicBond Installation Guide



1) Mechanically fasten the RUSS strip horizontally into the decking or into the upstand with the PS section being to the inside of the roof.



2) Apply ClassicBond Primer to the area on the underside of the EPDM membrane that will come into contact with the 75mm PS tape on the RUSS strip.

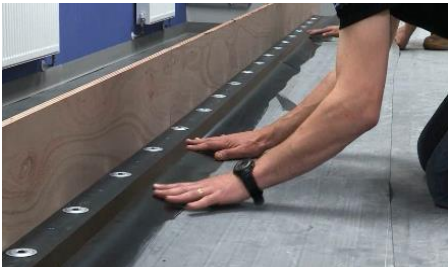

3) Once the primer is dry remove the protective strip from the PS tape on the RUSS strip. Lay the primed membrane into the PS tape with no wrinkles or air gaps and smooth in by hand then roll with hand roller.



4) Once bonded to the RUSS finish the upstand by using Bonding Adhesive to the remainder of the RUSS, upstand and membrane.

ClassicBond Installation Guide

BONDING ADHESIVE

[ClassicBond Bonding adhesive](#) is used on all vertical surfaces on the roof area, e.g. wall upstands, batten and sky light edges. This adhesive will work on porous and non-porous surfaces, providing they are clean and dry. The Bonding glue will enable tight angles to be formed quickly and easily to give great product versatility.



1) Apply the Bonding adhesive to the side of the RUSS strip or exposed decking. Also apply the Bonding adhesive to the relevant upstand termination or step down and to the back side of the ClassicBond membrane.



2) Once the adhesive has become touch dry with no wet puddles, mate the two surfaces together. Leaving no voids between the ClassicBond membrane and the receiving surface



3) Applying positive pressure to the membrane work the membrane up the upstand to the desired height. These areas should be rolled to achieve a strong bond between membrane and substrate.

ClassicBond Installation Guide

PIPES/PENETRATIONS IN MEMBRANE

When laying out the field sheets and a pipe or penetration is encountered, roll the folded membrane to the pipe. Be sure to maintain the proper alignment of the sheet with the roof edge, wall, and seams.

- Make a straight cut from the pipe to the nearest edge of the field sheet.
- Cut a hole to match the diameter of the pipe and roll the field sheet around the pipe.
- Check the final position off the sheet. Fold the membrane back and begin the bonding procedure.
- After the field sheet has been glued and broomed into place, apply a ClassicBond 150mm (6") wide Cured Cover Strip over the entire cut in the field sheet from the pipe to the outside edge of the sheet.

See the "Prefabricated Pipe Boot" section of this manual for further information on finishing this detail.

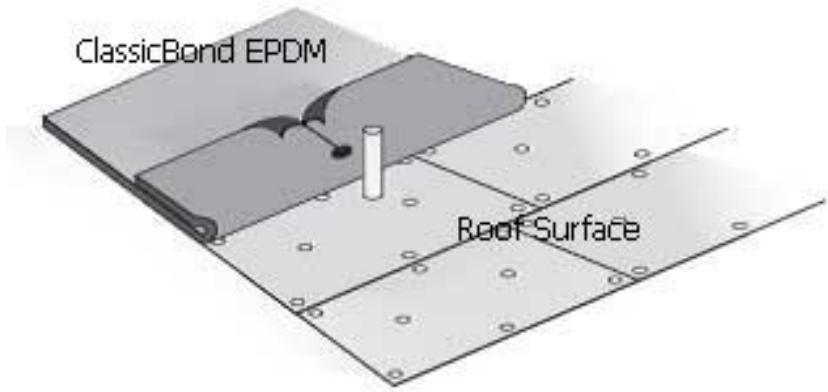

ClassicBond Installation Guide

SKYLIGHTS & CHIMNEY

- Prior to applying the adhesive, and while maintaining proper sheet alignment with walls, perimeter edges and other protrusions, unroll the membrane up to the base of the unit.

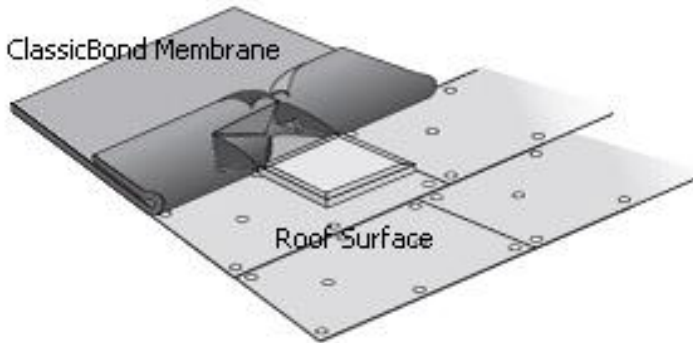

- Measure the width and depth of the unit and transfer the corresponding dimensions onto the folded membrane. Draw an “X” inside the box. Cut the “X” mark and from one corner cut a straight line to the nearest edge of the membrane.
- Roll the membrane around the unit, leaving a triangle of membrane turning up each one of the four (4) sides.
- After all cuts are made and the membrane has been correctly positioned, fold the membrane back and begin bonding procedures.
- After the field area is complete, bond the triangles up the sides of the unit (chimney, skylight, etc.). Take care to bond the membrane into the angle change so that the membrane is completely adhered.
- After the field sheet has been glued and broomed into place, apply a ClassicBond 150mm (6”) Cover strip over the entire cut in the field sheet from the curb to the end of the sheet.

ClassicBond Installation Guide

PERIMETER WALLS

The membrane on the wall should be a continuation of the deck membrane, base tie-ins are used at the perimeter of the roof.

The membrane should extend up the wall as far as possible to prevent the possibility of moisture infiltration behind the membrane. The membrane must extend up the wall a minimum of 150mm.

Vertical Termination

Wall Trim

- After the desired flashing height is attained and the membrane has been adhered.
- Insert the trim into the previously cut chase and mechanically fix into place using RB fasteners at a max spacing of 500mm..
- Apply a bead of Lap Sealant along the top of the trim and wall.

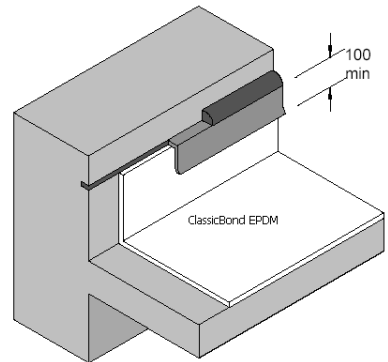

Coping Stone

- Lay ClassicBond EPDM 2/3rds across the wall, using Bonding adhesive and apply a bead of water cut off mastic under the outside edge of membrane and compress.
- Apply an even bed of mortar from the membrane and onto the out brick wall
- Lay suitable coping stones ensuring they have sufficient over hang and drip channels.

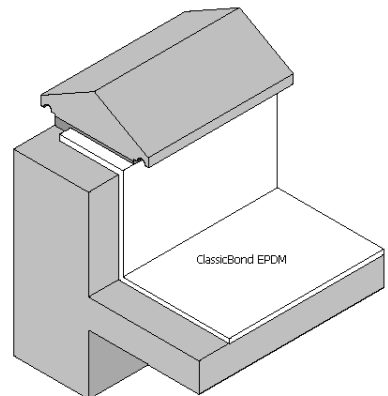

ClassicBond Installation Guide

SEAMS

SEAMING WITH 75mm PS TAPE

The membrane should be positioned so that the width of the seam is 75mm (3"). Mark a line 5mm (1/4") from the leading seam edge.



1) Fold the top sheet back to expose the seam area. Using a scrubbing pad apply the ClassicBond Primer to the seam area. Apply the primer past the seam edge to the line.

ClassicBond Primer must be dry before application of PS tapes. NOTE: If the EPDM membrane is contaminated with dirt, etc., clean the seam area.



2) Using moderate pressure set the Seam Tape into place to keep air from being trapped under the tape and unroll the 75mm wide tape along the length of the seam, aligning the Seam Tape (not the clear backing) along the chalk line. Care must be taken not to get any bubbles or wrinkles in the tape.



3) Lay the top membrane onto the Seam Tape. Pull away the poly backing from the tape at a 45° degree angle to the seam. While removing the poly backing, draw your hand across the seam, from the back to the leading edge. Roll the seam at right angles to the seam direction, not along it.

ClassicBond Installation Guide

150mm PS Cover Strip

When butt jointing of ClassicBond membrane or seaming to a metal drip or similar a 150mm cover strip is used.



1) Ensure there is no gap between the membrane when butt jointing. The 150mm tape should be centrally located over the joint.



2) Apply ClassicBond Primer to the area to be seamed. Apply primer 80-100mm either side of the join in the EPDM sheets.



3) Once the ClassicBond Primer has dried, peel back 150mm of the poly backing and press the PS tape into the primed area. Once the tape is held in position, peel back the poly backing and smooth the tape into the primed area. Progress along the seam.



4) Once the entire length of tape is applied to the seam, roll across the 150mm tape with hand roller. Where 150mm tapes intersect other tapes, 225mm uncured tape cover patches must be applied.

ClassicBond Installation Guide

T-JOINTS

A T-Joint is formed when two sheets of membrane form a seam that travels under, or over, a third section. The centre of the “T” is where the three sheets intersect.

- Use [ClassicBond Uncured Flashing](#) to form T-Joint patches. T-Joint patches should be at least 150mm (6”) x 150mm (6”).
- Apply primer to membrane surface before applying T-Joint patches.

NOTE: All T-Joint Patches should be thoroughly rolled with a steel or silicone hand roller.

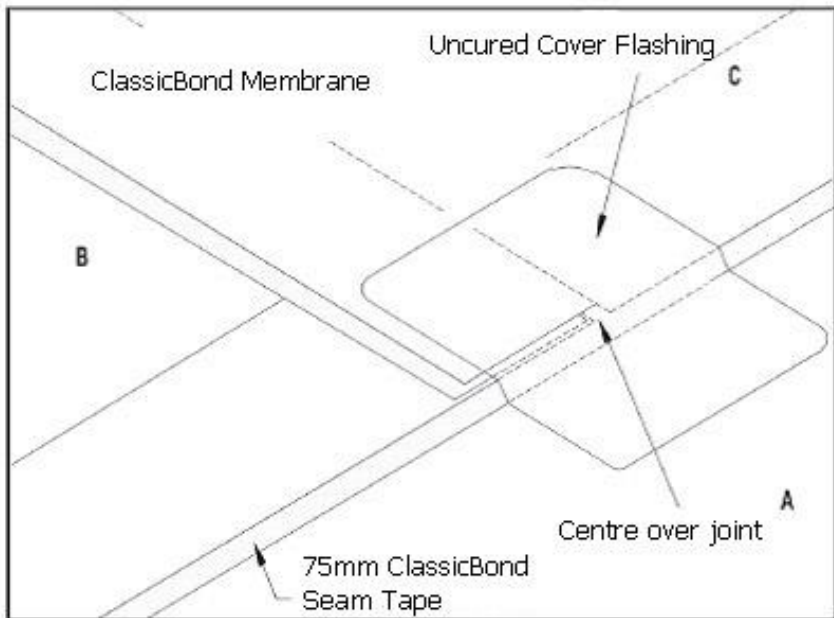

ClassicBond Installation Guide

INTERNAL CORNER

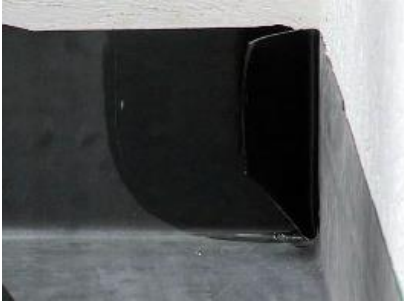

1) The fold should be cut back to leave a 75mm wide flap. Apply ClassicBond EPDM Primer to the front & back of the flap and to the membrane on the wall. ClassicBond Primer must be allowed to dry before application of PS tape.



2) Cut an appropriate size piece of 225mm uncured flashing (min. 50mm wider than the flap of membrane), press the flap back to the upstand and install the uncured flashing tape.



3) Roll the taped area with hand roller once installed.

ClassicBond Installation Guide

EXTERNAL CORNERS

1) Cut the ClassicBond EPDM membrane at 45° angle to allow the membrane to run around the corner and create both upstands. Bond in place with ClassicBond Bonding Adhesive. Cut a section of 225mm Uncured PS tape to a min. 75mm onto deck and 50mm past angled cut in membrane.



2) Apply ClassicBond Primer to the marked area to be flashed and allow to dry. The area must be clean and dry before application of primer, apply primer to membrane and to upstand substrate. ClassicBond Primer must be allowed to dry before application of tapes.



3) Start installing the tape from the top point. Work the tape down upstands first and into the bottom angle change.



4) Work the tape onto the deck around the corner and smooth out and roll the entire flashing with hand roller.

ClassicBond Installation Guide

PRE FABRICATED PIPE BOOT



1) Cut the [ClassicBond PS Pipe Seal](#) above the raised “rib” one size smaller than the pipe diameter. DO NOT CUT THROUGH THE RIB. Pull pipe seal over pipe until base flange is in contact with the ClassicBond EPDM membrane.



2) Once in position clamp the seal to the pipe with the supplied metal clamp and mark around the base of the seal to give a line to prime up to. Pull pipe seal upwards on pipe to expose the membrane and apply ClassicBond EPDM Primer to the EPDM deck membrane



3) Pull pipe seal back down over pipe and into position. Remove poly backing from the tape and with hand pressure press tape onto primed area. Roll splice area with a hand roller

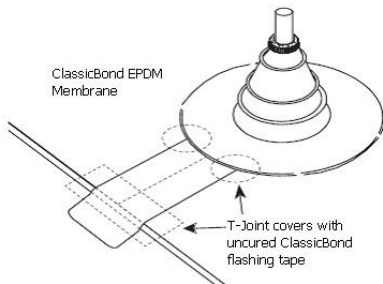

Apply ClassicBond uncured T-Joint Patches where pipe seal intersects a field splice.

NOTE: Temperature of the pipe must not exceed 82° C (180° F)

ClassicBond Installation Guide

PIPE AND PENETRATION FLASHINGS

To fabricate a pipe boot or flashing for other penetrations follow the procedures on the following pages using ClassicBond Uncured Flashing.

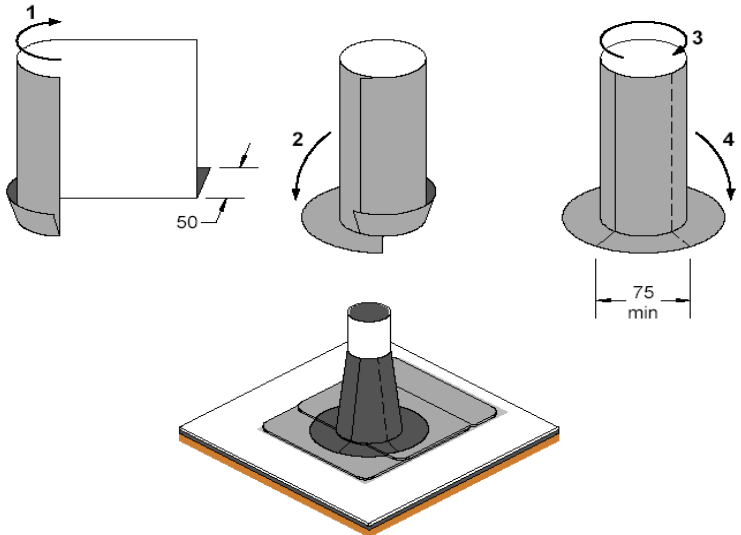
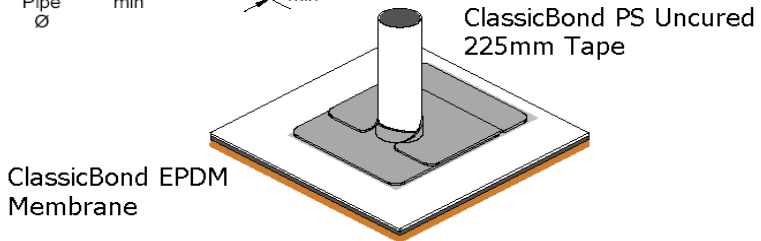
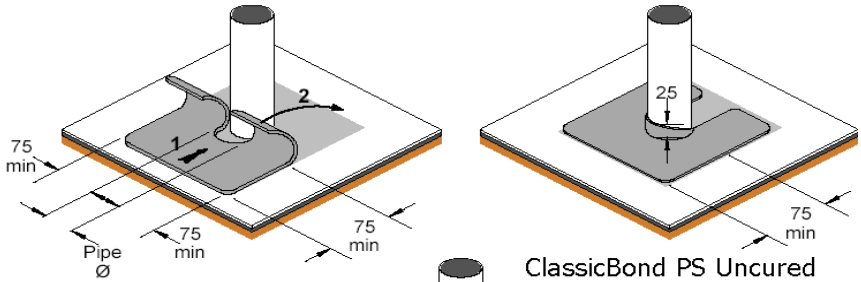

ClassicBond Installation Guide

Internal Drain

There are two basic methods for sealing to an internal drain. ClassicBond Pre-made outlets of various types can be used for standard outlets or an on-site method may be used for non-standard outlets.

Anti-backup drain for 68mm outlet

These are [68mm roof outlets](#) designed to be inserted into the existing 68mm diameter down pipe. The outlet is fitted with an anti-backup seal to achieve a watertight joint. The outlet is attached to the membrane using 225mm PS uncured flashing tape. A Leaf grate for this outlet is also available.



1) Cut the outlet flange back to leave a min. 50mm head and cut the membrane back to meet the perimeter of the outlet head. Secure the outlet into the decking and apply ClassicBond Primer to the head of the outlet and to the EPDM membrane.



2) Apply the Uncured PS tape to the primed area. Once fitted cut a small section from the centre of the tape out to expose the outlet opening and press the remaining tape down into the outlet. Roll the entire flashing with hand roller.



3) Finally install the leaf grate to complete the 68mm flat roof outlet.

ClassicBond Installation Guide

ClassicBond Top Drain

These are designed for [110mm flat roof outlets](#) to allow high water flow on larger roofs.



1) Fit the outlet into the roof before installing the membrane; ensure the outlet has the yellow protective cap installed. Install the ClassicBond EPDM membrane to the roof and over the outlet, place cutting guide over the pin and cut round the circular plate.



2) Remove the circular section of membrane and the yellow protective cap from the outlet.



3) Insert a bead of [ClassicBond Water Cut Off mastic](#) between the underside of the membrane and the top flange on the outlet. Screw in the clamping ring till it's completely tightened. Use the two tightening lugs to apply leverage to the ring.

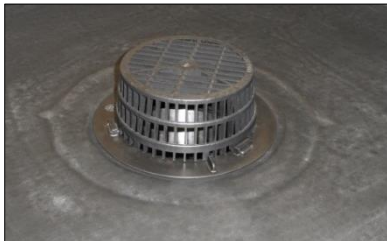

4) Install the leaf grate into the three locating tabs.

ClassicBond Installation Guide

Angled Roof Drain

For roofs designed with horizontal drains to go through walls and pitched roofs. The [ClassicBond Angled Roof Drain](#) is fitted to the deck and sealed to the membrane using 225mm PS Uncured flashing tape.



1) Install outlet into parapet wall before installing EPDM membrane. Install the ClassicBond EPDM membrane over the outlet with ClassicBond Bonding Adhesive. Cut the EPDM membrane away from outlet opening by 50mm. Apply ClassicBond Primer to the membrane, outlet face and into the outlet pipe.



2) Install Uncured PS tape to the outlet. This should be large enough to join onto the membrane by a minimum of 50mm. Cut a small square out of the middle of the tape and mould the tape into the outlet pipe by 25mm. Cut a second section of Uncured PS tape 100mm wide. This will be inserted into the outlet pipe to reinforce and lengthen the tape that was turned into the pipe by 25mm. Apply

ClassicBond Primer to outlet pipe and to already installed tape before application.



3) Once the second section of tape is installed, complete by inserting the leaf grate into the outlet.

ClassicBond Installation Guide

FOR NON-STANDARD OUTLET DESIGN

This method uses just the [225mm PS uncured flashing](#) tape to seal the membrane to the outlet pipe.

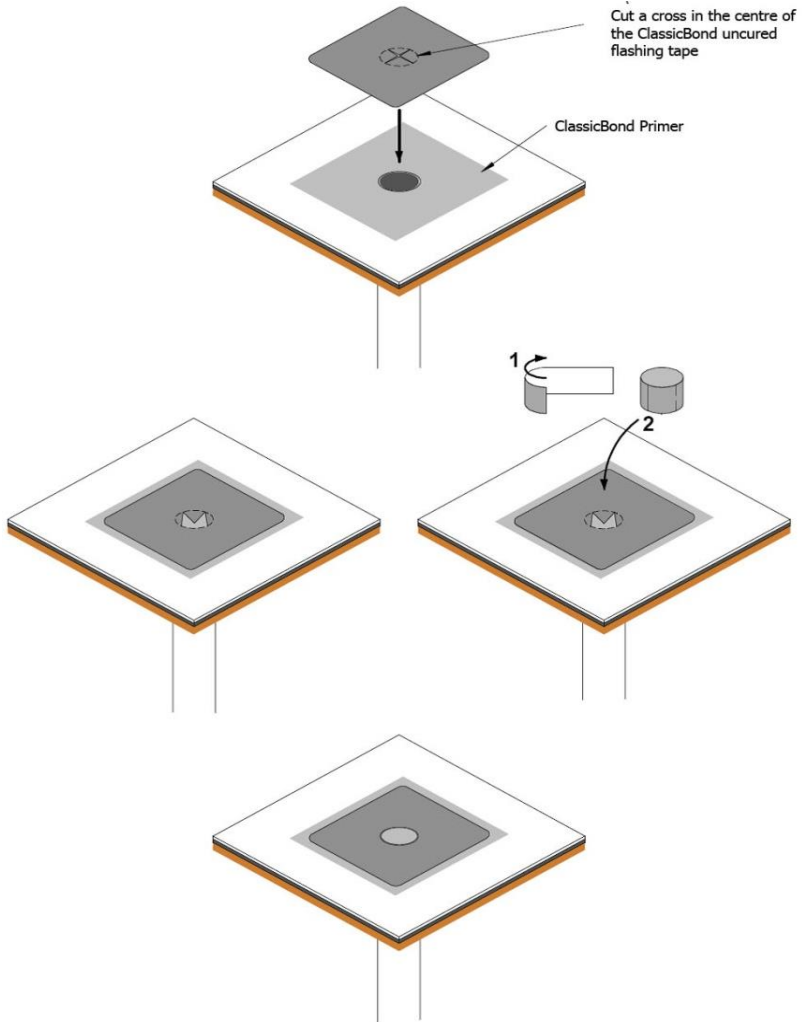

ClassicBond Installation Guide

EPDM to BUR join

There are two alternate methods to be used when the new ClassicBond roof joins directly onto a neighbouring flat roof.

The diagram below shows a cold termination and simple guidelines to follow in the planning stage of the roof.

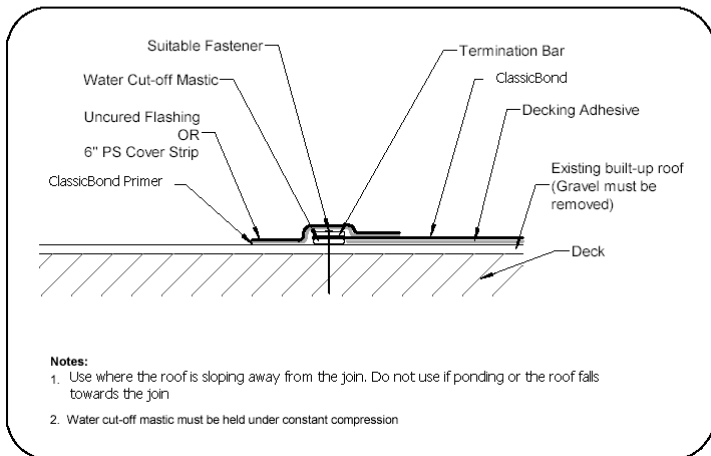
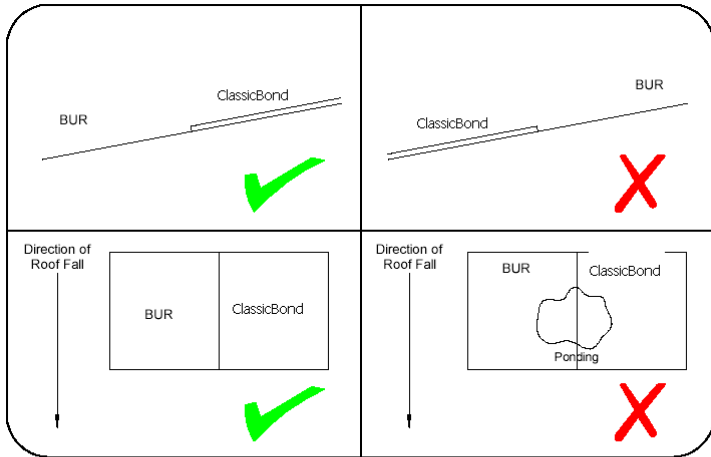

ClassicBond Installation Guide

Edge Terminations

Sure Edge PVC Perimeter Trims

Offering a fast simple, good looking finish to the flat roof system. See more at www.sureedge.co.uk.

Gutter System

This is available in two options, standard and built in batten back plate. The standard requires a timber batten to be installed first then the back plate fixed to it. The “Built in Batten” doesn’t require the extra timber batten.



- Fix the 25mm x 40mm back plate to the fascia at the edge of the roof.
- Allow minimum 50mm ClassicBond membrane to go over the back plate
- Position the front plate with foam seal to clamp the membrane between the 2 sections and fully fix into place with supplied fixings.
 - Between lengths allow 2.5mm expansion joint for each trim

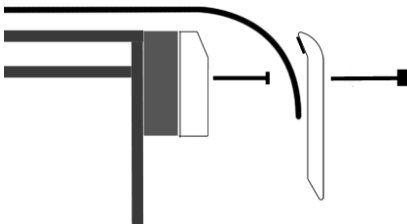

ClassicBond Installation Guide



Gutter Trim Joiner

Install joint covers by hooking the clip under the bottom of the clip under the front plate and clipping the top over.

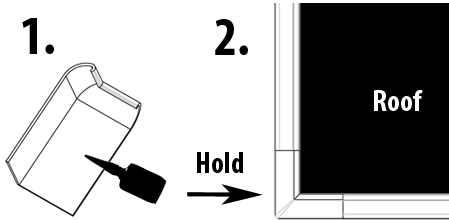

Gutter Corners

External

- Apply the adhesive to one side of the corner
- Push down into position and hold till adhesive is set.

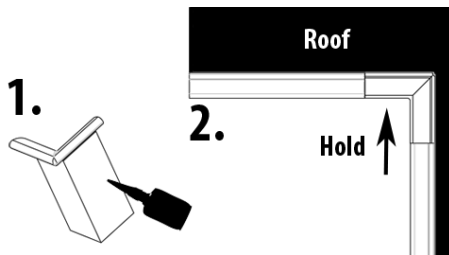

Internal

- Apply the adhesive to one side of the corner
- Push down into position and hold till adhesive is set.

ClassicBond Installation Guide

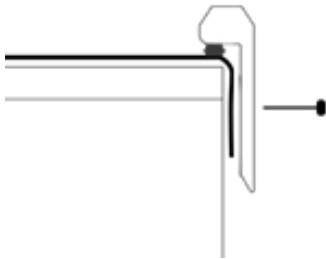

Sure Edge Check Kerb System

Used to create upstand and edge trim in one component.

- Lay membrane and allow minimum 50mm overhang.
- Ensure membrane is clean, position edge trim and firmly push down to compress foam seal by min. 30%.
- Fix trim into place using supplied fixings.
- Between lengths allow 2.5mm expansion

joint for each trim.



Kerb Joiner

Install joint covers by hooking the clip under the bottom of the clip covers by hooking the clip under the bottom of the clip under the front plate and clipping the top over.

1.

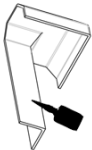

2.

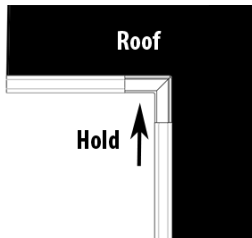

Internal Corner

- Mitre the trims so they fit together with foam seal compressing between the two trim ends
- Apply adhesive to one side of the corner
- Fit over trims and hold in place till set.

ClassicBond Installation Guide

1.

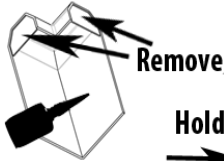

2.

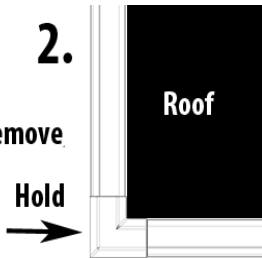

External Corner / Stop End

This universal corners is designed for both external check corners and stop end for gutter.

External Corner

- Mitre the trims so they fit together with foam seal compressing between the two trim ends
- Remove the two blanking plates
- Apply adhesive to one side of the corner
- Fit over trims and hold in place till set.

1.

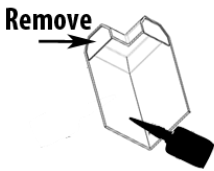

2.

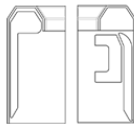

3.

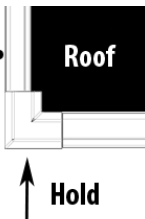

Stop End

- Remove one blanking plate for the relevant side
- Apply adhesive to one side of the corner
- Fit over trims and hold in place till set.

Disclaimer

All the information in this product sheet is based on practical experience and is published in good faith. However, because we have no control over the manner or conditions in which our products are used, or over work undertaken or end product manufactured by the purchaser, we cannot accept liability for results.

Responsibility for ascertaining the suitability of products for their purposes rests with the purchaser. All conditions, representations, statements, warranties or guarantees whatsoever, whether express, implied or statutory, in respect of any goods manufactured, sold or supplied by us are hereby expressly excluded and we accept no liability in respect of any claim for damage or consequential loss caused to any property arising directly or indirectly out of the use of our products or goods.

Flex-R Ltd., Sandwood House, Hillbottom Road, Sands Industrial Estate, High Wycombe, Bucks, HP12 4HJ

Tel: 01494 448792, enq@classicbond.co.uk, www.classicbond.co.uk